



expert plus reversible key system

Greater protection and
convenience for your
master key system

Secure
Convenient
Flexible



Do you need more security?

Configure expert according to your requirements

The dormakaba expert plus reversible key system can be customised for the customer on site by authorised local locksmiths. They are therefore also the sole point of contact for key copies. Its versatility makes it ideal for securing and organising access to any building – not only to family homes and residential complexes but also to public buildings and industrial properties.

Areas of application

- Healthcare
- Office buildings
- Hotels & catering
- Education
- Industry & production
- Shopping & retail sector
- Privately owned housing
- Government & administration
- Sport & culture
- Transport & logistics

Your advantages at a glance

- Long-term protection by European patent EP2890856B1*
- High level of security through compliance with relevant standards, for example EN 1303 and DIN 18252
- Certificates according to VdS-B and VdS-BZ
- Technical construction protects against the most common opening methods
- Modular system structure for economic adjustment to new requirements
- Reversible key without sharp edges can be inserted from both sides
- expert cross with additional active element for high copy protection
- Optional security elements and special functions for even higher levels of protection
- Flexible in its use with basic to highly complex master key system types
- Can be combined with electronic access systems from dormakaba
- Environmental Product Declaration (EPD) available

Security combined with convenience: Reversible key and lock cylinder

Ergonomic reversible key –
can be inserted from
both sides

Individual dealer code –
for key copies only from
dormakaba approved
locksmiths

**No sharp corners or
edges** – no tears in
clothes and bags

Robust nickel silver –
for a long service life

High quality clips –
in 12 different colours

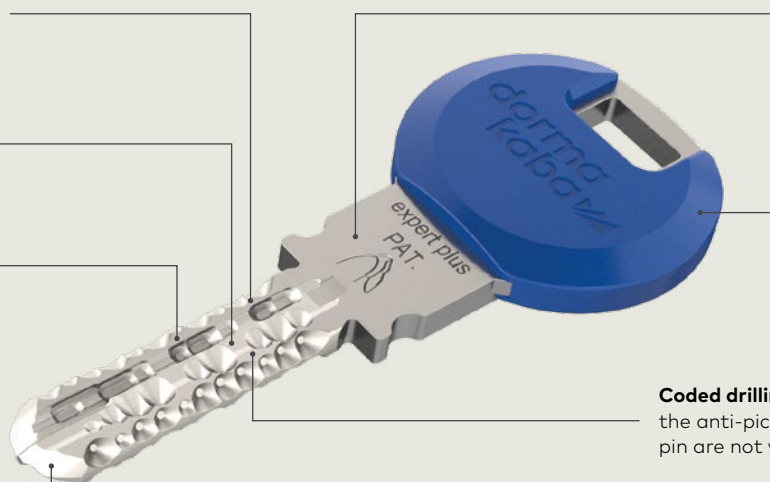

Coded drilling pattern –
the anti-picking positions of the tumbler
pin are not visible on the key

Special coding – on the key
tip – protects against illegal
key copies

**4 radially arranged tumbler pin rows
with up to 22 pairs of pins** – prevent
attack using the bumping or
picking methods

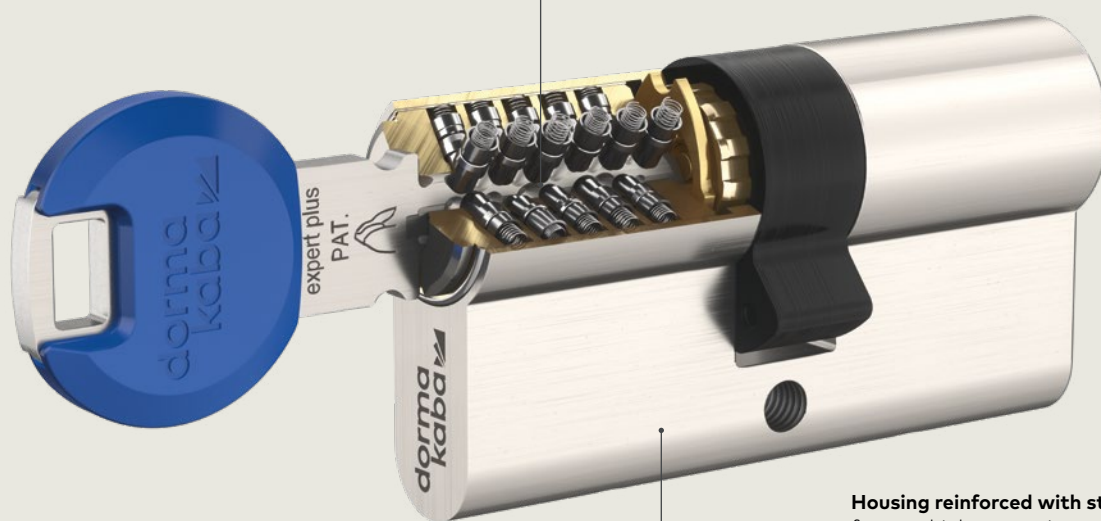

Housing reinforced with steel shims –
for very high protection against pulling
(optional)

All-round protection as standard

- The high number of undivided pin pairs and the hardened steel materials used protect against the most common opening methods.
- Using the bumping method (Rapido method), to open the lock cylinder is not realistic under real operating conditions.

Even more technical features on request

- Depending on the requirements, additional security features, such as steel reinforcement shims, anti-drill or pulling protection, can be selected.
- Dust, insect or weather protection help depending on the installation.
- Different rotary knob variants offer greater convenience (e.g. design thumbturn knob) and coupling functions (e.g. key override from both sides or priority function).

expert cross – copy protection at the highest level

In the expert cross system, there is a cross-shaped recess with a movable active element in the key. When the key is inserted, the movement of the active element is queried by matching security elements in the lock cylinder. The matching lock cylinder can only be opened and closed if the movable active element is present in the key.

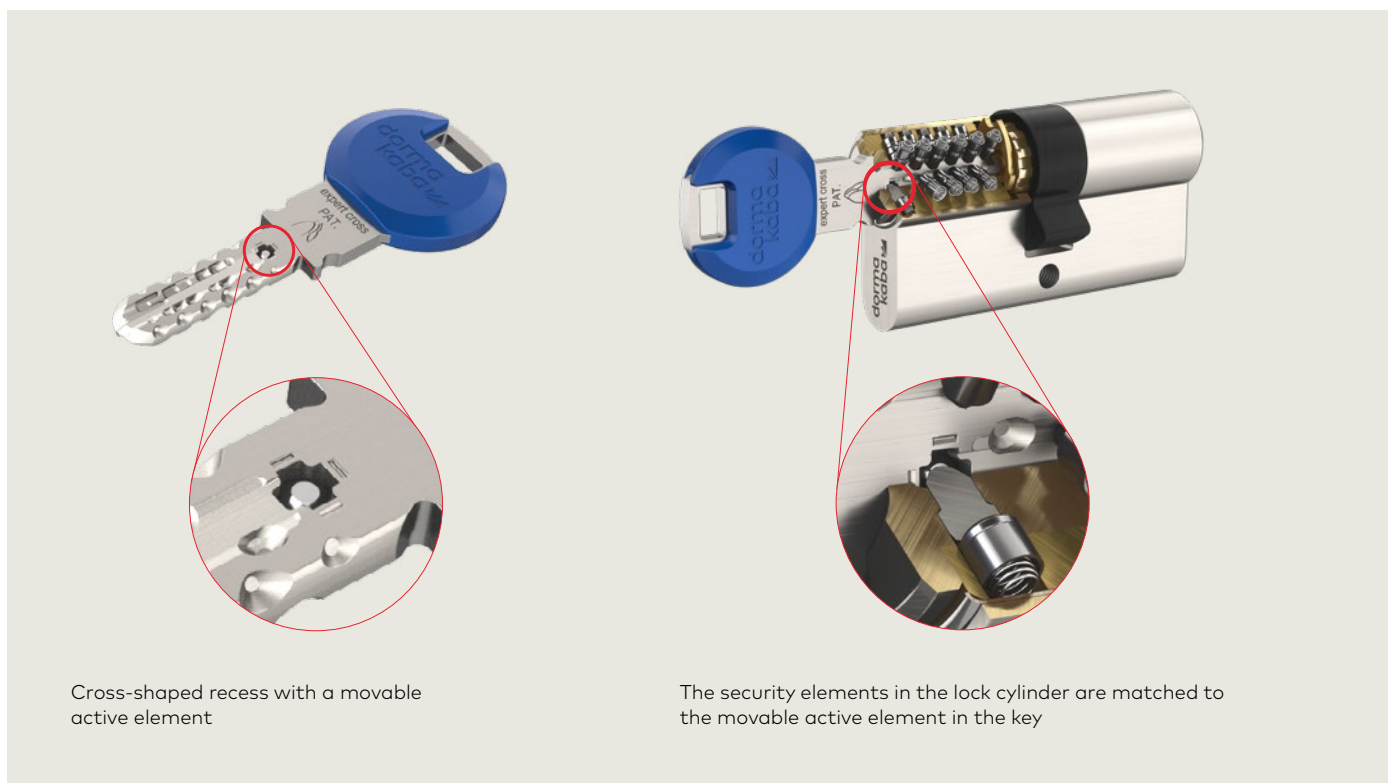

Our commitment

Security and sustainability



Patent protection

expert is protected by European patent EP2890856B1* - valid until 2033.
expert cross is additionally protected by EP3280854B1* – valid until 2036



Mountain
Peak

Brand protection

Our systems are additionally marked with a logo that is protected as a figurative mark and that makes them easy to identify. This figurative mark symbolises that this is an original key produced by dormakaba. Duplicate keys are exclusively manufactured by dormakaba.

Security card

Every new expert plus and expert cross master key system and every serial cylinder is supplied with a security card containing all the security information about the system. This is used to manage the master key system data and to identify the owner when ordering key copies.



Standards and certificates expert plus and expert cross

- EN 1303 Key Related Security Grade 6 and Attack Resistance Grade D for versions with steel reinforcement in the housing
- Additionally available Safety standards/Certificates
 - DIN 18252 Grade C and D
 - VdS Grade B+ and BZ+
- Fire protection: Lock cylinder tested according to EN 1634-1 and EN 1634-2

*Not valid in all countries – see worldwide.espacenet.com for details

Our Sustainability Commitment

We are committed to foster a sustainable development along our entire value chain in line with our economic, environmental and social responsibilities toward current and future generations.

Sustainability at product level is an important, future-oriented approach in the field of construction. In order to give quantified disclosures of a product's environmental impacts through its entire life cycle, dormakaba provides Environmental Product Declarations (EPDs), in which the results of the life cycle assessment (LCA) are presented.

Please download the EPD and read more about our sustainability commitment [here](#) or use the QR code provided.



Environmental product declaration: EPD

- Declaration number: EPD-DOR-20210182-CBA1-EN
- In line with ISO 14025 and EN 15804+A2
- Publisher and declaration holder: Institut Bauen und Umwelt e.V.



You design your master key system. The possibilities are endless

Support with planning

expert plus and expert cross can be used freely with all master key system types – from the one-key-for-all solution for home use, to large, complex sites with different access authorisations. The basis is a key plan, according to which selected keys can open a series of specific doors.

To design the key plan, we examine and evaluate our customers' requirements in detail. This means that you will have better control, save costs incurred by duplicate keys and reduce the total number of keys.

Different applications require different solutions



Private homes



Residential complexes



Office buildings or company sites



Large and complex facilities or public facilities,
e.g. universities or schools

Types of master key systems.

Applications and principles

Master key systems

Application: e.g. in office buildings or schools.

There are individual closings, but also one or more parent keys (master keys) which lock all cylinders within the system.

Individual keys (ES):
only close specific doors



Lock cylinders or doors



Administration

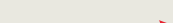

Sales

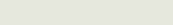

IT



Master key (HS):
closes all doors

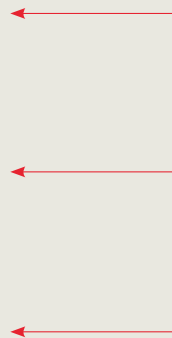

Grand master key systems

Application: e.g. in large office buildings or universities.

Here, the functions of a master key system are expanded by the grand master key, additional main group keys and group keys.

Group keys (GS):
closes a specific area



Lock cylinders or doors



Sales 1

Individual keys (ES):
only close specific doors

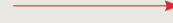

Sales 2



IT

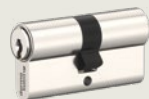
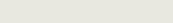
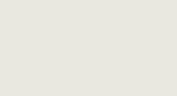

Accounting



Grand master key (GHS):
closes all doors

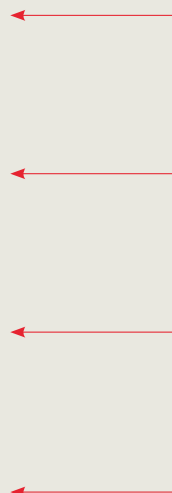

Keyed-alike lock cylinders

Application: e.g. for family homes.

All or selected lock cylinders can be locked with the same key. This simplifies handling and reduces the size of the key ring.

Lock cylinders or doors



Front door



Garage



Mailbox



Padlock

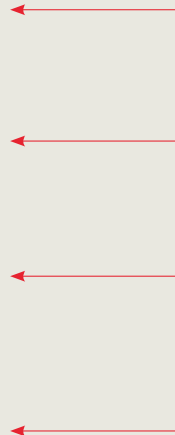

Several lock cylinders with the same keying can be opened with the same key.

Central master key systems

Application: e.g. in residential complexes.

Several different individual keys can close central lock cylinders. In addition, there are individual closings, which can each only be closed by one key.



Apartment 1



Surface mounted lock



Mailbox



Flat 2



Surface mounted lock



Mailbox



Apartment 3



Surface mounted lock



Mailbox

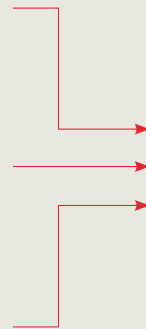

Central cylinders:

- Front door
- Garbage room
- Bicycle storage
- Garage



With the special **administrator master key system**, the main areas of several properties (i.e. several locking systems) in different locations can be closed with only one key (administrator key).

Key variety.

clarity through colour

Select the shape and function of the key



Default key with black clip



Key with Largekey clip



Key with nickel silver long key bow



Key with RFID transponder clip for integration into electronic access control systems

Colours as a visual aid



For the **default key**, there are SmartKey clips in 12 colours.



The **key with a Largekey clip** is available in 12 colours.



The **RFID transponder clips** have 6 coloured ring elements for easier identification.

Free choice of lock cylinders

The cylinder programme features a wide variety of types to choose from. You can also integrate cylinder for cabinet locks, key-operated switches or lift controls into the

system. Choose between nine surface finishes to match your design.

Extract Cylinder Lock Types



DZ

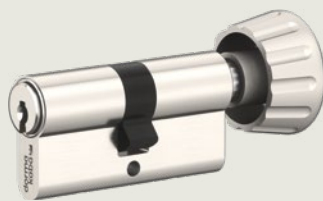

DKZ



HZ

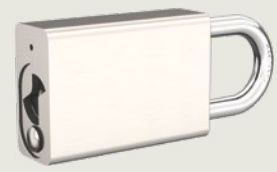

VHZ



AZ



BMZ

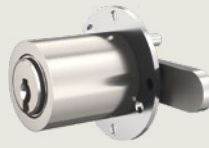

MZ

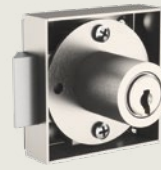

MAS



SZ

- DZ Double cylinder
- DKZ Thumbturn cylinder
- HZ Single cylinder

- VHZ Padlocks
- AZ Rim cylinder
- BMZ Camlock

- MZ Cylinder cabinet locks
- MAS Furniture dead lock
- SZ Key Switch cylinder

Finishes

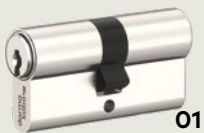

01

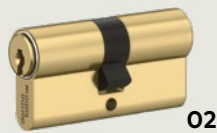

02

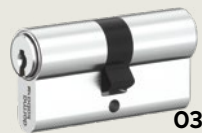

03

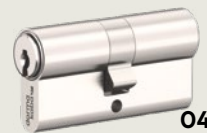

04

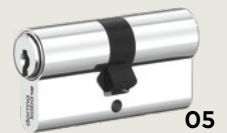

05

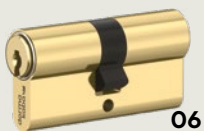

06



07



08



09



10

- 01 NI | Natural nickel*
- 02 MS | Natural brass*
- 03 CR | Chrome-plated standard
- 04 NIC | Chemically nickel-plated

- 05 CRP | Polished chrome
- 06 MP | Polished brass
- 07 BH | Light brown
- 08 BM | Medium brown
- 09 BD | Dark brown
- 10 BKM | Black matt

Cylinder surfaces not colour-reproducible.

1) Standard surface

Modular construction.

Maximum flexibility

Quick and inexpensive to adapt

expert plus and expert cross reversible key systems offer high levels of investment protection, even when requirements change over the years. A modular, upward-compatible system structure allows for quick and easy conversion of the lock cylinders to other lengths and types. The existing lock cylinder can be adapted to a new length with little effort, for example for a new entrance door, or can be fitted with an elegant thumbturn knob.

Economically sustainable

The core of the system are modular, interchangeable inserts, which can be used without any problems in all cylinder lock types, for example single cylinders, thumbturn cylinders, rim cylinders, cylinders for cabinet locks, padlocks and camlocks. The combination of different lengths of cylinder housings (complete housings), couplings and cam hubs opens up almost unlimited possibilities for the conversion of a provided access solution.

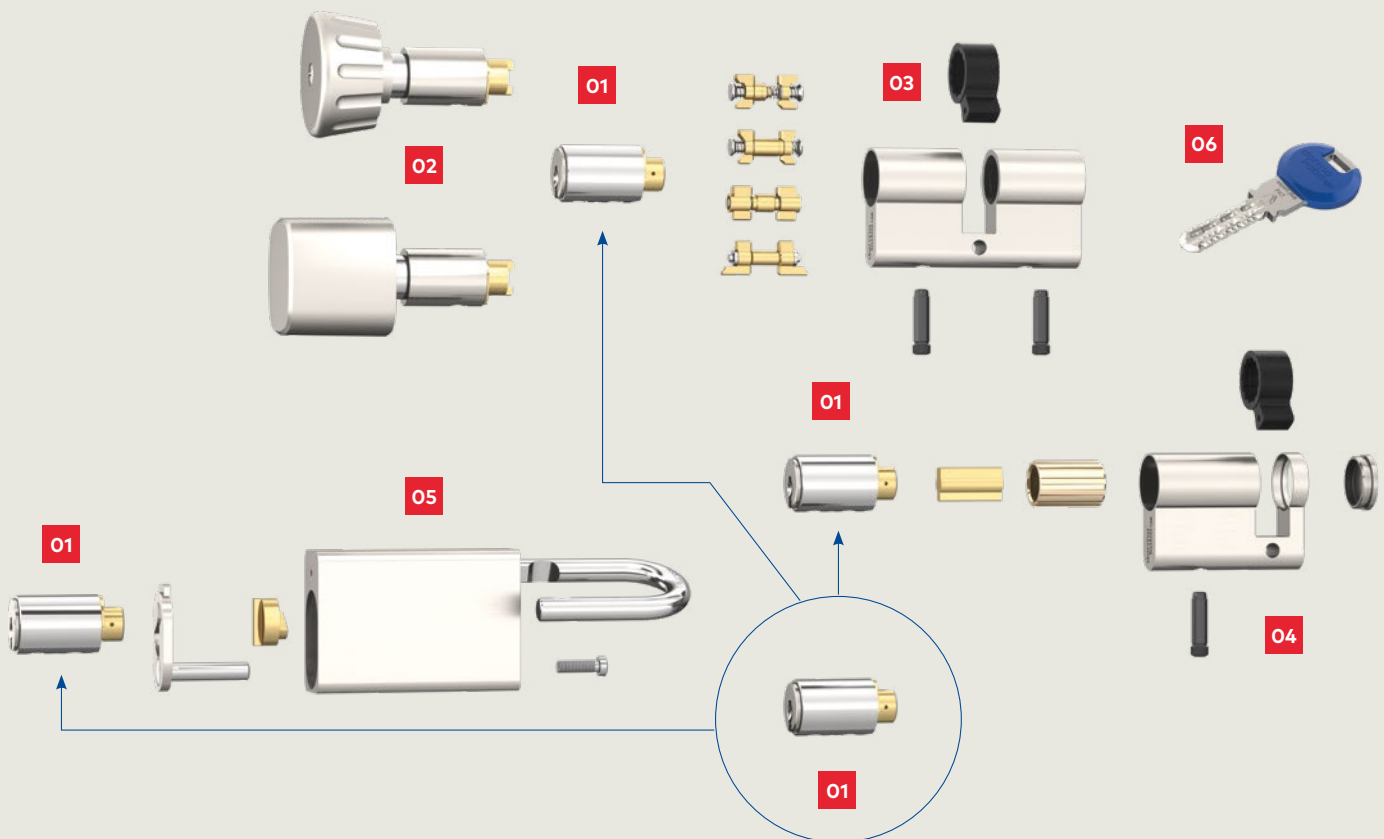

01
The modular insert contains the locking authorization for the keys and can be integrated into all reversible key cylinder types.

02
A thumbturn knob can be retrofitted very easily.

03
Different lengths of the double cylinder housing enable easy length conversion.

04
Single cylinder with an insert.

05
Padlock with an insert.

06
Key with locking authorization according to the key plan.

Added value for your master key system.

Useful special functions

Depending on your requirements, you can supplement your individual solution with one of our numerous special functions. These offer added value in terms of functionality and benefits. For details, please refer to the **Special functions for reversible key systems** brochure.

Service function (SAT)

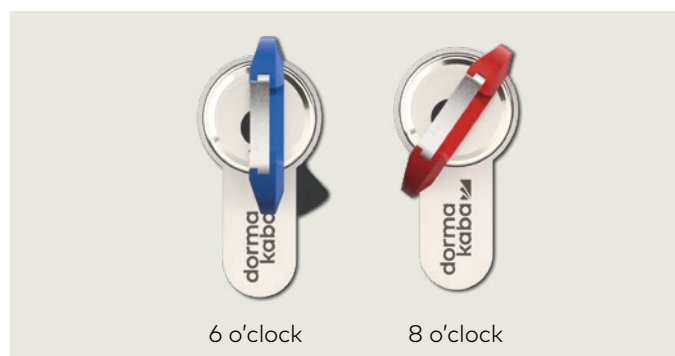

Temporary access for service personnel?

Just turn the key! There is an owner key and a service key. If the owner key is withdrawn from the SAT lock cylinder in the "8 o'clock" position by the home owner, for example, the door can also be opened with the service key. If the owner key is withdrawn out in the "6 o'clock" position, the door cannot be opened from the outside with the service key.

Thermally insulated lock cylinder (TIC)

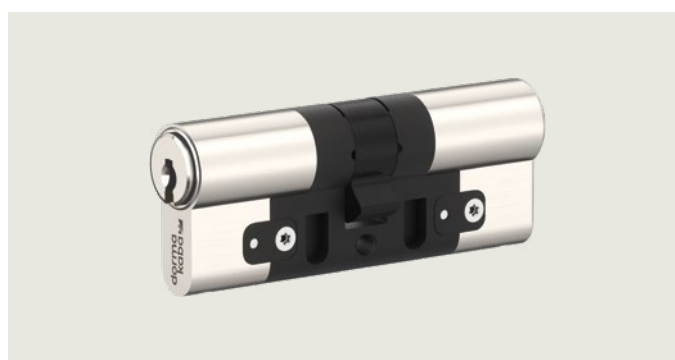

Cold and damp outside? Everything dry inside. The separation of the outside and inside with plastic components ensures thermal insulation. Condensation cannot form on the inside of the door, even when it is extremely cold. A foam rubber seal on the outside of the lock cylinder protects against drafts and driving rain.

Construction phase function (BAZ)

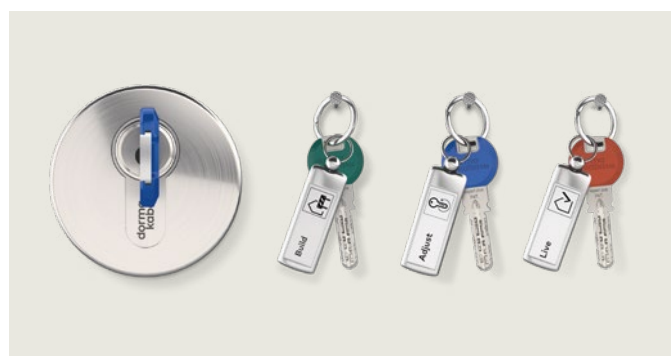

Modify access authorisation in a flash? Possible with the

3-in-1 lock cylinder. Using the BAZ cylinder, you can withdraw the access authorization of different keys or key groups simply by means of a conversion key. So, whether you want to withdraw access rights for a particular person or have lost a key, there is no need to change the lock cylinder.

Lock cylinder with key override on both sides (BSZ)



Key left in the lock? Not a problem! The double cylinder makes it possible to unlock the door from the opposite side with an authorised key when a key is inserted on one side and rotated in any direction. The inserted key turns with it. This function is guaranteed to work on both sides of the double cylinder.

We make access in life smart and secure

Our Offering

Door Hardware
Entrance Systems
Electronic Access & Data
Interior Glass Systems
Mechanical Key Systems
Lodging Systems
Safe Locks
Key Systems
Movable Walls
Services



Consulting
Planning
Realization
Operation
Maintenance

Our Focused Industries



Financial
Industries



Airports



Offices



Healthcare



Utilities / Telecoms



Residential



Multi-Family-
Housing



Production
Facilities



Government



Rail



Education



Retail



Hospitality



Our Values

Customer first

We always focus what we do on the needs of our customers, partners and users.

Curiosity

We constantly scout for trends as the inspiration for future-focused solutions.

Performance

We go the extra mile to ensure customer satisfaction and set the bar high in terms of security, quality and reliability.

Courage

We are committed to continuously developing solutions that generate genuine added value for our customers and users.

Trust

Our core corporate value is at the heart of everything we do, so customers can rest assured that they are in good hands.

Our Company

More than

150

years of experience



Around

15,000

employees
worldwide

130

countries

ISO 9001
Certificate



More than

2,000

patents



Sustainability Report
GRI Standards



stock-listed at

SIX Swiss Exchange (DOKA)

We call it
trusted access



**Door
Hardware**



**Electronic
Access & Data**



**Mechanical
Key Systems**



Lodging Systems



**Entrance
Systems**



**Interior Glass
Systems**



Safe Locks



Service

dormakaba
International Holding AG
Hofwisenstrasse 24
CH-8153 Rümlang
T +41 44 818 90 11
info@dormakaba.com
www.dormakaba.com