

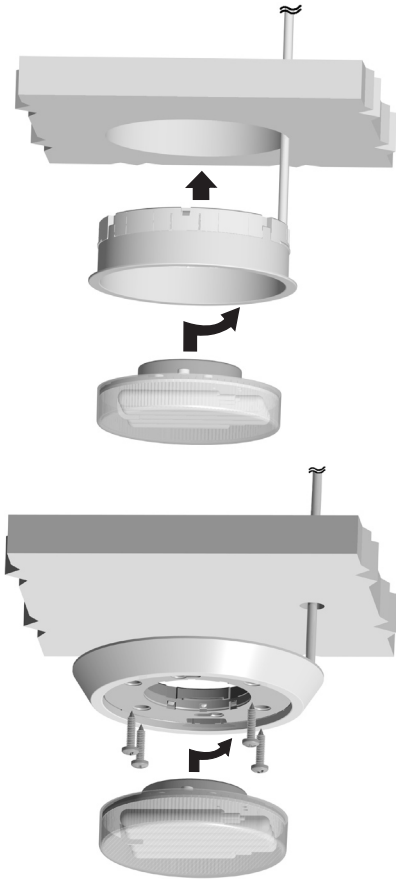





> **MONTAGEANLEITUNG**
ASSEMBLY INSTRUCTIONS
NOTICE DE MONTAGE
ISTRUZIONI PER IL MONTAGGIO

Typ LD 5000-7
Einbau- / Aufbauversion
Fitted- / mounted version
230V 50/60Hz 6W



	ILCOS: FBSH-6W-GX53 <small>oder /</small> LED Lamp GX53 (ELEKTRA)	
	Schutzklasse II	degree of protection II
	geeignet zum Ein- und Anbau in Möbel	suitable for installation on/ into furniture
	Geeignet zur Installation an normal entflammaren Baustoffen (z.B Holz)	suitable for installation on panels of normal inflammable material
	EU Konformitätskennzeichnung	EU conformity marking

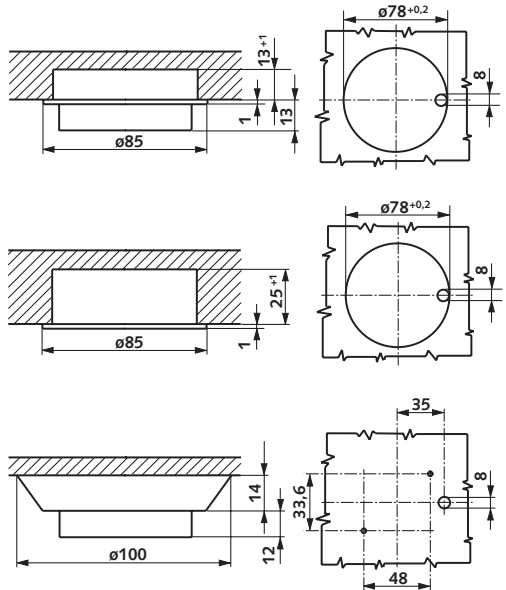

1. Die Montage der Leuchte in/an Metallteile ist unzulässig.
 2. Die Anschlussleitung dieser Leuchte ist nicht auswechselbar. Falls die Leuchte beschädigt ist, muss sie vernichtet werden.
 3. Die Leuchte ist nicht für die Montage auf oder in normal entflammaren Materialien geeignet, wenn sie durch Wärmedämmmaterial umhüllt ist.
-
1. The light must not be installed to metal parts.
 2. The connection lead of this light cannot be replaced. If the light is damaged it has to be destroyed.
 3. If the light is covered with heat-insulating material it is not appropriate for installation to normally inflammable material.



ELEKTRA

ELEKTRA GMBH
 Werkstraße 7
 D-32130 Enger
 Telefon 052 23/185-0
 Fax 052 23/1 72 56